

Lowel Blender™.. Intuitive LED Lighting

Daylight, Tungsten, or In-between, on Location.

The new Lowel Blender™ is the perfect solution for today's 'run & gun' video lighting needs.

- You intuitively mix twin arrays of high CRI LED's, until you see the right blend of color to suit your mixed source environment.
- Put beautiful fill-light on your talent that's all tungsten, all daylight, or more importantly that perfect mix of the 2 that suddenly makes your shot look naturally lit. Blender makes location lighting intuitive.
- Blender packs more punch than you've come to expect from compact LED lights. The lamphead's compact size (4 x 3 x 3") makes it small enough to fit on a pistol grip or compact light stand.
- Blender comes with a set of front diffusers for variable softening & diffusing of the blended output.
- Blender can be powered by popular video camera batteries on a belt-clip, or its own compact AC supply.



Easy to Use Intuitive Controls



Intuitively Light Your Shot to Match Your Location.



Originally designed by cinematographer Tom Robotham, the Lowel Blender is the location LED light you've been waiting for.

Light Output

Lowel Blender™ with Daylight & Tungsten LED's at full brightness

With Supplied Lite Frost Diffuser			Without Diffuser		
Distance	Foot Candles	Lux	Distance	Foot Candles	Lux
2 ft	418	4509	2 ft	621	6708
4 ft	111	1198	4 ft	169	1824
6 ft	50	544	6 ft	76	820
8 ft	29	310	8 ft	43	466

Lowel Blender™ Patent Pending

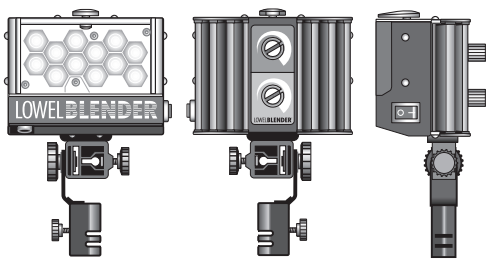

Bring Compact, Powerful, & Versatile LED Lighting to Your Next Interview

Introducing the Lowel Blender 3 Light Kit



Todays run & gun video shooter can easily find themselves in a variety of lighting sources during the course of their day.

Tungsten incandescent, office fluorescent, daylight, or the dreaded office setting that contains a mix of all three.

Now you can work quickly in any of these settings with full creative flexibility, using the Lowel Blender 3 Light Kit.

- Kit contains 3 Lowel Blenders with diffusers, plus compact Uni-stands, and auto-setting AC adaptors in a compact Slim Litebag.
- Each Blender has 2 sets of LED's, in Tungsten & Daylight color, which are quickly & easily blended to your desired color output. Diffusers vary the character of the light.
- Light to match the color temperature of your location, or contrast it to create a sense of depth & drama. You have creative control, light it the way you see it.
- Room inside for accessory Camcorder Battery Sled 3 Packs or industry standard battery cables.



Easy to Use Intuitive Controls



3 Blenders, used in different colors, combine for perfect interview lighting.



Tungsten



Household Fluo



Daylight

Lowel Blender matches your location's existing light, adding the perfect amount of fill in the same color temperature.

Lowel Blender Technical Data

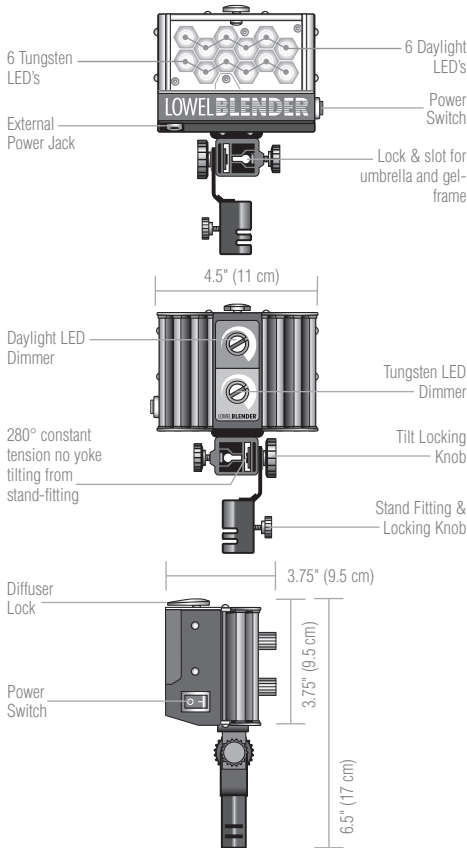

Size: 6.5 x 4.5 x 3.5", (17 x 11 x 9 cm)
Weight less cable: 1.2 lbs. (550 g)
AC Wattage draw: 16 Watts, per fixture
Max. amperage: 1.25 - 3 amps per fixture, depending on input voltage
Beam control: Fixed focus LEDs with accessory diffusers to vary quality
Fits on: 5/8" (1.59 m) studs and accessories
Materials: Primarily aluminum steel, & thermo plastic
Switch: in-head
Patent Pending

Lowel Uni-stand

Uni-stand

Code: UN-33

Weight: 2.4 lbs (1.1 kg)

Size: 21.5" (54.6 cm) folded.
 Extends to 7"11" All aluminum stand, wide base, legs can lie flat to floor, large locking knobs. Folds compactly to fit in smaller kits.

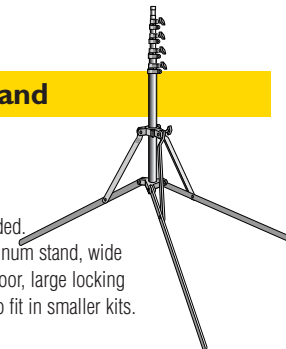

Lowel Slim Litebag

Code: LB-24

Size: 23 x 9 x 6"
 (58 x 23 x 15 cm)

Weight: 3.5 lbs (1.6 kg)

New Litebag, more compact than Lowel Small Litebag (LB-30). Made of polyester with vinyl coated backing. Supplied with velcro partitions, and padded shoulder strap (SS-10).

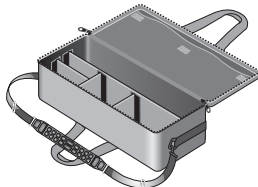

Performance

The below charts show foot candle readings for Lowel Blender, at full combined brightness (both daylight & tungsten LED's), as well as daylight and tungsten LED's separately at full brightness. Readings are shown with & without supplied Lite Frost front diffuser attached.

Without Diffuser

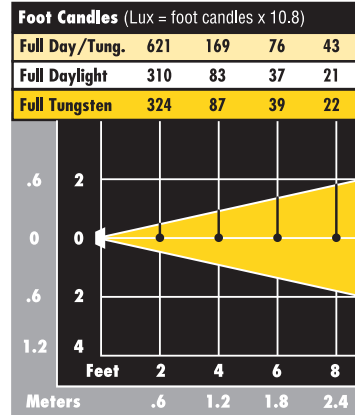

With Lite Frost Diffuser

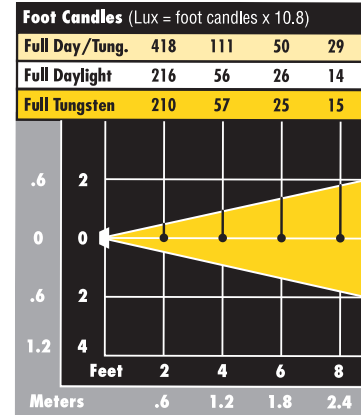

Beam angles-points at which intensity drops to 50% of maximum.

Readings taken with Minolta CL-200 meter.



Blender 3 Light Kit

Code: BLN-9340LB

Weight: 17 lbs (7.7 kg)

3 Lowel Blenders (BLN-10), each with supplied front clear safety plastic, auto voltage-setting AC adaptor (with 120v Edison & 240v 2 pin Euro plugs), & 3 accessory front diffuser, 3 Lowel Uni-stands (UN-33), 1 Slim Litebag (LB-24)

DC Battery Options

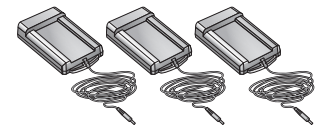

Camcorder Battery Sled 3 Packs

Pack of 3 battery sleds. Accepts below listed DV camcorder batteries to power Lowel Blender. With belt clip, and velcro strap for hanging from stand.

Panasonic Camcorder Battery Sled 3 Pack

Code: BSLD-113

Canon Camcorder Battery Sled 3 Pack

Code: BSLD-133

Sony Camcorder Battery Sled 3 Pack

Code: BSLD-123

Cigarette Plug Cable

Code: BL-85

Adapts Blender power connector jack to Cigarette Lighter plug for battery use. Length, 5 ft.



4-Pin XLR Cable

Code: BL-82

Adapts Blender power connector jack to male 4-pin XLR plug for battery use. Length, 5 ft.



Anton Bauer D-Tap Cable

Code: BL-83

Adapts Blender power connector jack to male Anton Bauer D-Tap plug for battery use. Length, 5 ft.

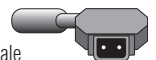

AC Adaptor

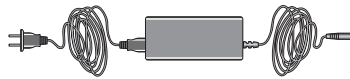

DC Power Options

Battery Sleds for Panasonic, Canon, & Sony camcorder batteries

Battery Cables for Cigarette Lighter, 4-Pin XLR, and Anton Bauer D-Tap connectors

Accessory Slot

for Gel frame or umbrella

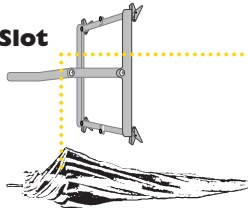

Front

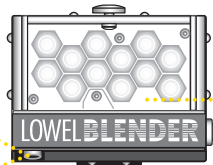

Back

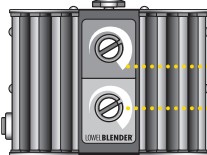

Accessory Front Diffusers

 Lite Frost

 Cracked Ice

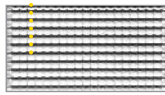
 Prismatic

LED Controls

Daylight

Tungsten

Lights & Packs

Lowel Blender

Code: BLN-10

Lowel Blender with supplied front clear safety plastic, auto voltage-setting AC adaptor (120v Edison plug), & 3 accessory front diffusers.

Code: BLN-10E

Same as above, but with 240v Euro AC cord connection to AC adaptor.

Lowel Blender AC/DC Pack

Code: BLN-911LB

1 Lowel Blender with auto voltage-setting AC adaptor (120v Edison plug) & 3 front diffusers (BLN-10), Panasonic camcorder Battery Sled, Handle & Stud (ViP-431) in Blender Single Carry Bag.

Same as above with:

BLN-912LB Sony Battery Sled

BLN-913LB Canon Battery Sled

Code: BLN-911LBE

Lowel Blender AC/DC Pack, as above, but with 240v Euro AC cord connection to AC adaptor.

Same as above with:

BLN-912LBE Sony Battery Sled

BLN-913LBE Canon Battery Sled

Lowel Blender Duo AC/DC Pack

Code: BLN-921LB

2 Lowel Blenders as described above (BLN-10), 2 Panasonic camcorder Battery Sleds, Handle & Stud (ViP-431) and Blender Duo Carry Bag.

Same as above with:

BLN-922LB Sony Battery Sleds

BLN-923LB Canon Battery Sleds

Code: BLN-921LBE

Lowel Blender Duo AC/DC Pack, as above, but with 240v Euro AC cord connections to AC adaptors.

Same as above with:

BLN-922LBE Sony Battery Sleds

BLN-923LBE Canon Battery Sleds

Kits

Lowel Blender I Light Kit

Code: BLN-9145LB

1 Lowel Blender as above (BLN-10), 1 Panasonic camcorder Battery Sled, 1 Lowel Uni-stand (UN-33), 1 Slim Litebag (LB-24, see below)

Same as above with:

BLN-9146LB Sony Battery Sled

BLN-9147LB Canon Battery Sled

Note: for the above kit(s) with 240v Euro AC cable connection to AC Adaptor, add "E" to end of code.

DC Battery Options

Panasonic Battery Sled

Code: BSLD-11

Accepts Panasonic standard DV camcorder batteries to power Lowel Blender. With belt clip, and velcro strap for hanging from stand.



Canon Battery Sled

Code: BSLD-13

Accepts Canon standard DV camcorder batteries to power Lowel Blender. With belt clip, and velcro strap for hanging from stand.



Sony Battery Sled

Code: BSLD-12

Accepts Sony standard DV camcorder batteries to power Lowel Blender. With belt clip, and velcro strap for hanging from stand.

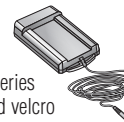

Cigarette Plug Cable

Code: BL-85

Adapts Blender power connector jack to Cigarette Lighter plug for battery use. Length, 5 ft.



4-Pin XLR Cable

Code: BL-82

Adapts Blender power connector jack to male 4-pin XLR plug for battery use. Length, 5 ft.



Anton Bauer D-Tap Cable

Code: BL-83

Adapts Blender power connector jack to male Anton Bauer D-Tap plug for battery use. Length, 5 ft.

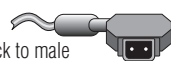

Kit Cases

Slim Litebag

Code: LB-24

Size: 23 x 9 x 6" (58 x 23 x 15 cm)

Weight: 3.5 lbs (1.6 kg)

New Litebag, more compact than Lowel Small Litebag (LB-30). Made of polyester with vinyl coated backing. Supplied with velcro partitions, and padded shoulder strap (SS-10).

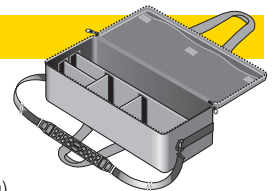

Mounts

Uni-stand

Code: UN-33

Weight: 2.4 lbs (1.1 kg)

Size: 21.5" (54.6 cm) folded.

Extends to 7'11" All aluminum stand, wide base, legs can lie flat to floor, large locking knobs. Folds compactly to fit in smaller kits.

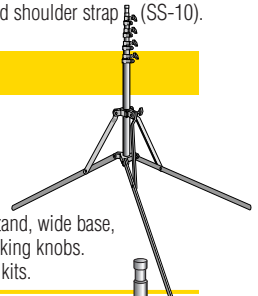

Handle & Stud

Code: ViP-431

Weight: 3 oz (85 g)

For hand holding Lowel Blender light. Updated Handle with 1/4-20 screw-threaded post, and 5/8" Stud with 1/4-20 screw-thread hole in bottom. Replaces ViP-43 Handle & Stud-link.



Low-link

Code: ViP-37

Weight: 1 oz (28 g)

It enables the Blender light to be camera-mounted with a Cam-link or a 1/4-20 screw.



Stud-link

Code: ViP-38

Weight: 1 oz (28 g)

5/8" (1.59 cm) stud with 1/4-20 screw, supplied with the Vipod. Can be used with Cam-link or directly on some video cameras.



Cam-link

Code: ViP-41

Weight: 1 oz (28 g)

Locks onto video cameras that have a female shoe. It accepts a Low-link, L-link, or Stud-link.



Cam-link & Stud-link

Code: ViP-41S

Weight: 2 oz (57 g)

Cam-link & Low-link

Code: ViP-41L

Weight: 2 oz (57 g)

For mounting Blender to a camera shoe.